





Thrust

Unmounted bearing assembly consisting of through hardened housing and shaft plate (raceways) with cylindrical or tapered rolling elements separated by a centrifugally cast brass retainer (cage). Thrust bearings are ideal for applications with loads parallel to the shaft.

Bearing Configurations

Single Or Multistage

Rolling Element Styles

Cylindrical Or Tapered

Bore Diameter Size Range



1" To 18" (25.4 mm To 457 mm)

Materials

Bearing Quality Steel

Thrust Selection Guide



	Type	Description	Size Range
	Txxx	Cylindrical Roller Thrust	6" - 34"
	Atxxx	Aligning Cylindrical Roller Thrust	6" - 35"
	T-xxx	Tapered Roller Thrust	8" - 33"
	T-xxxx-F	T-flat Tapered Roller Thrust	10.5" - 34"
	T-xxxx-FS	Aligning T-Flat Tapered Roller Thrust	19" - 34"
	CTxxx	Crane Hook Thrust	3" - 18.5"
	WCTxxx	Crane Hook Thrust w/ Fitting	3" - 18.5"

* For estimating purpose only, individually sizes may vary and are subject to change without notification



Thrust Bearings **ROLLWAY**[®]

Thrust Bearings







DESIGN CHARACTERISTICS						FEATURES		Page No.
Static Load	Dynamic Load	Reversing Load	Higher Speed	Horizontal Installation	Relative Base Cost *	Self Aligning	Grease Fitting	
●	●	○	●	●	\$			F-13
●	●	○	●	●	\$\$	S		F-17
●	●	○	●	●	\$\$			F-27
●	●	○	●	●	\$\$			F-29
●	●	○	●	●	\$\$	S		F-30
●	●	○	○	●	\$\$		S	F-21
●	●	○	○	●	\$\$			F-21

Misalignment Capability
External Greasing

O = Optional
S = Standard
○ = Not Recommended
○ ● ● ● ●
Poor ← → **Best**

Thrust Selection Guide



	Type	Description	Size Range
	TAB-xxxx	2 Stage Tandem Thrust	4.3" - 34"
	TAC-xxxx	3 Stage Tandem Thrust	3.5" - 34"
	TAD/TMD-xxxx	4 Stage Tandem Thrust	3.9" - 12"
	TAF/TMF-xxxx	6 Stage Tandem Thrust	3.5" - 6"
	TMH-xxxx	8 Stage Tandem Thrust	3.5" - 14"

* For estimating purpose only, individually sizes may vary and are subject to change without notification



Thrust Bearings **ROLLWAY**®

Thrust Bearings



DESIGN CHARACTERISTICS						FEATURES			Page No.
Static Load	Dynamic Load	Reversing Load	Higher Speed	Horizontal Installation	Relative Base Cost *	Self Aligning	Grease Fitting	Oil Holes / Pathway	
●	●	○	◐	●	\$\$\$			S	F-35
●	●	○	◐	●	\$\$\$			S	F-36
●	●	○	◐	●	\$\$\$			S	F-37
●	●	○	◐	●	\$\$\$			S	F-38
●	●	○	◐	●	\$\$\$			S	F-39

Misalignment Capability
 External Greasing
 Relubrication and Long Bearing Life

O = Optional
S = Standard
○ = Not Recommended
 ○ ◐ ◑ ◒ ◓
Poor ← → **Best**

ROLLWAY® Thrust Bearings

Rollway Tapered Thrust Bearings

Rollway Tapered Thrust bearings utilize crowned tapered rolling elements separated by a machined brass roller riding retainer (cage) contained within precision ground shaft and housing plates. Inherent to the design, the self centering action of the tapered rollers provide “true rolling motion”. These attributes counteract the natural gravitational forces on the roller assembly when subjected to horizontal applications. Tapered thrust bearings are intended for high axial loads (load parallel to the axis of rotation). There are 3 types of Tapered Thrust bearings available, TTHD, TTVF, and Self Aligning TTVF. Depending on your preference, these bearings are available in a wide variety of sizes and options as illustrated on the pages to follow.

For a given shaft size and approximate envelope, the tapered thrust bearing’s dynamic capacity is considerably greater than a cylindrical roller bearing.

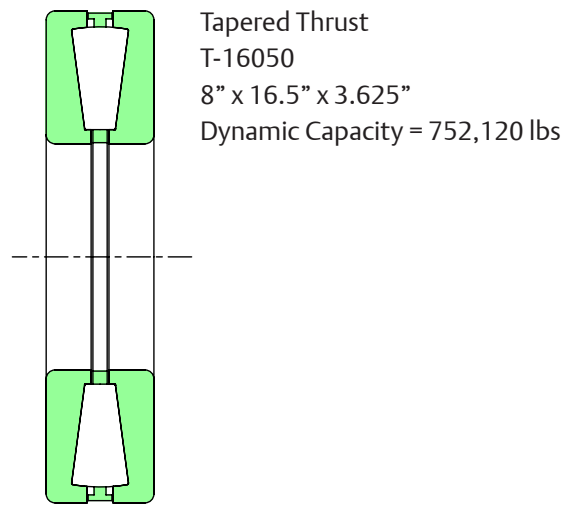
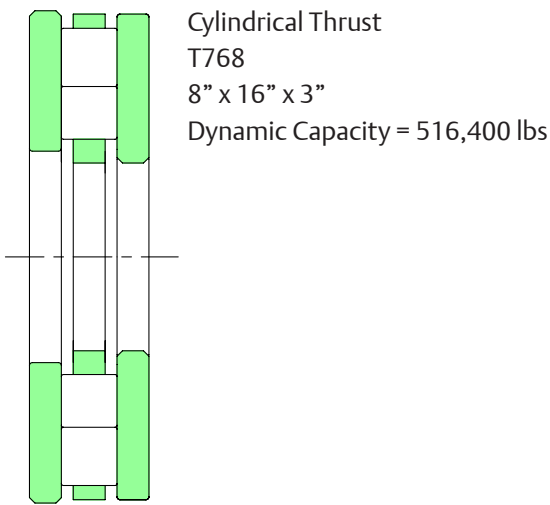



Tapered Thrust Nomenclature

Standard Thrust Nomenclature

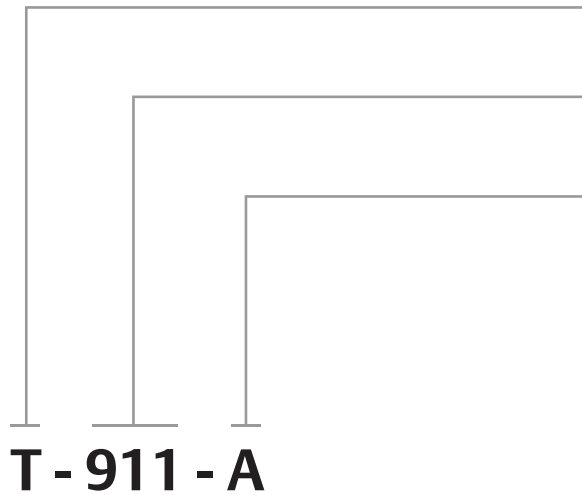

Type Designator

T - TTHD Style Thrust

Size Designator

Reference Catalog For Sizes.

Variation Code

A - Variation From Standard - Consult Catalog Or Application Engineering
 F - Full Complement Of Rollers
 V - Bearing Plates And Rollers Made From VIMVAR Or CEVM Steel

.....

T-Flat Nomenclature



Type Designator

T-F - TTVF Style

T-FS - TTVF Style With 2 Piece Aligning Plate

Size Designator

Bearing Bore And Outside Diameter Size. The First Three Digits Are The Bore Size And The Second Three Digits Are The O.D. Size. Example: 050105 Refers To A 5 Inch Bore And 10.5 Inch O.D.

Variation Code

201 To 215 Are Numerically Assigned Codes That Designate The Variation From Standard (Example 201 = 1st Variation, 202 = 2nd Variation, Etc.). These Bearing Code Numbers Do Not Reference The Modification From Standard. Application Engineering Must Be Contacted For Information Concerning A Particular Modification.

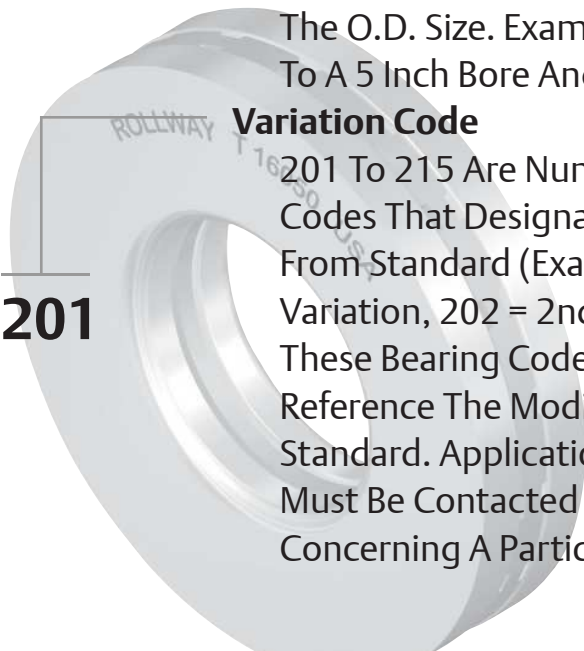

ROLLWAY® Thrust Bearings

Features and Benefits



Superior Performance in Horizontal Shaft Applications

Tapered thrust bearings have been found to have superior performance in horizontal shaft applications. The self centering action of the rollers helps counteract the gravitational effect of the roller assembly, thus reducing the possibility of the roller assembly contacting the shaft.

Steel

The plates and rollers are made from case hardened carburizing bearing grade steel. Upon request we can manufacture the components from CEVM or VIMVAR grades of material.



Precision Ground Inner and Outer Plates

All thrust plates are accurately ground for flatness and parallelism of roller riding and backing surfaces. Locating diameters are ground to obtain an accurate fit on the shaft or in the housing. The surfaces of the plates are ground to provide a long operating life. The guide rib on the tapered plates is spherically ground to match the roller and reduce friction. All tapered thrust plates are designed to be used with a full complement of rollers, which makes it possible to supply this version for any size. Rollway tapered thrust plates are manufactured from Carburizing Bearing Grade Steel. The surfaces are precision ground to ABMA standards. Unlike the cylindrical thrust, these plates can be used as either the shaft or housing plate.



Precision Ground Tapered Rollers

All rolling elements are precision ground and graded to provide an even distribution of load over the contact surfaces. Rollers are crowned for optimum contact stress patterns by reducing the end stress between the roller and the thrust plates. The large ends of the rollers are spherically ground. This provides controlled contact between the rollers and the guide rib, thus enhancing the flow of lubricant. These rollers are manufactured from Carburizing Bearing Grade Steel.

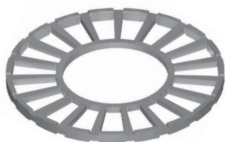

Machined Brass Retainer

The TTHD taper thrust bearing retainers are machined from a single piece of centrifugally cast brass. The retainer is designed to pilot on the thrust plates' flanges. The roller pockets are accurately machined at right angles to the thrust force which will be applied to the bearing. By virtue of their design, tapered thrust bearings provide true rolling motion when compared to cylindrical thrust bearings whose rollers tend to have a minimal amount of slippage due to the fundamental design.



Features and Benefits continued



Pin through Steel Type Retainer – T-Flat Type

The T-Flat retainers are “pin through” style (pins extend through the center of the roller). The retainer consists of two steel rings through which the hardened steel pins are secured. An alternate design is a retainer machined from a single piece of centrifugally cast brass with each roller retained by two pins.

Types and Styles

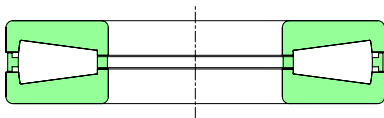

Standard Tapered Thrust Style

Rollway tapered thrust bearings (TTHD Style) are engineered for applications that are under the harshest industrial conditions. These bearings feature tapered rollers positioned between two plates with tapered raceways.

The tapered thrust differs significantly from the cylindrical roller thrust as there is true rolling motion with the vertex of the conical sections intersecting the bearing axis. When the bearing is loaded, the rollers exhibit an outward force that is countered by the plate’s outer guide rib. The large spherical end of the roller is counter bored to help improve lubrication between the roller and guide rib. By virtue of the additional contact surface these bearings will have a higher dynamic capacity than a similar sized, cylindrical roller thrust bearing.

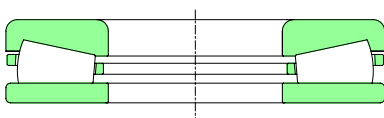

T-Flat Style

The T-Flat is similar to the TTHD style except one plate is flat. The guide rib on the one tapered raceway resists the induced radial force component caused by the inclined plane while the flat plate allows radial displacement without adversely affecting bearing operation. Maximum capacity is achieved through close spacing of rollers through the use of a steel, pin type retainer.

ROLLWAY® Thrust Bearings

Thrust Bearings



- Basic Construction Type:** Standard Tapered Roller (TTHD Style)
- Rolling Elements:** Crowned Tapered Rollers With Sphered Ends
- Bearing Material:** Case Carburized Bearing Grade Steel
- Retainer Types:** Machined Brass Or Pin Through Steel Type

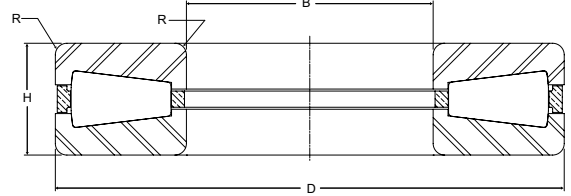

Tapered Thrust Bearings

Part No.	B	D	H	R	Bearing Weight	C	Co
	Bore	Outside Diameter	Height	Housing & Shaft Fillet		Basic Dynamic Rating	Basic Static Rating
	inch mm	inch mm	inch mm	inch mm		lb kg	lb/N
T-411	4.000 101.60	8.500 215.90	1.813 46.05	.13 3.3	20 9.1	219,100 981,570	762,700 3,416,900
T-411F	4.000 101.60	8.500 215.90	1.813 46.05	.13 3.3	20 9.1	268,000 1,200,640	988,000 4,426,240
T-441	4.400 111.76	8.800 223.52	2.200 55.88	.13 3.3	25 11.3	234,000 1,048,320	822,000 3,682,560
T-451	4.500 114.30	9.875 250.83	2.125 53.98	.16 4.1	31 14.1	305,000 1,366,400	1,096,000 4,910,080
T-520	5.000 127.00	9.875 250.83	2.188 55.56	.19 4.8	31 14.1	328,000 1,469,440	1,094,000 4,901,120
T-511	5.000 127.00	10.500 266.70	2.313 58.75	.19 4.8	37 16.7	322,500 1,444,800	1,232,570 5,521,910
T-511A	5.063 128.60	10.500 266.70	2.313 58.75	.19 4.8	37 16.7	322,500 1,444,800	1,232,570 5,521,910
T-511F	5.063 128.60	10.500 266.70	2.313 58.75	.19 4.8	37 16.7	408,000 1,827,840	1,687,000 7,557,760
T-611	6.000 152.40	12.500 317.50	2.750 69.85	.25 6.4	66 29.9	455,125 2,038,960	1,672,410 7,492,400
T-651	6.500 165.10	12.250 311.15	3.500 88.90	.25 6.4	71 32.2	375,000 1,680,000	1,472,000 6,594,560
T-661	6.625 168.28	12.000 304.80	2.750 69.85	.25 6.4	56 25.4	382,620 1,714,140	1,323,000 5,927,040
T-691	6.875 174.63	14.125 358.78	2.313 58.75	.25 6.4	93 42.2	539,980 2,419,110	2,023,000 9,063,040
T-711	7.000 177.80	14.500 368.30	2.313 58.75	.31 7.9	109 49.4	601,700 2,695,620	2,101,000 9,412,480
T-711F	7.000 177.80	14.500 368.30	2.313 58.75	.31 7.9	96 43.5	611,000 2,737,280	2,936,000 13,153,280
T-709	7.000 177.80	17.000 431.80	4.000 101.60	.13 3.3	241 109.3	229,000 1,025,920	3,245,000 14,537,600

Metric dimensions for reference only.

Not all parts are available from stock. Please contact customer service for availability (800) 626-2120.

For more information on bearing capabilities outside of our standard offering, please contact Application Engineering (800) 626-2093.

Thrust Bearings **ROLLWAY**[®]



- Basic Construction Type:** Standard Tapered Roller (TTHD Style)
- Rolling Elements:** Crowned Tapered Rollers With Sphered Ends
- Bearing Material:** Case Carburized Bearing Grade Steel
- Retainer Types:** Machined Brass Or Pin Through Steel Type

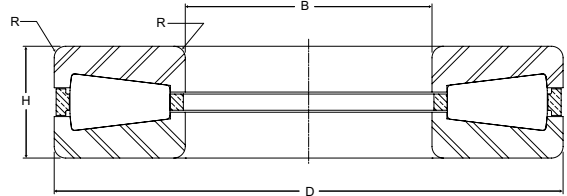

Tapered Thrust Bearings

Part No.	B	D	H	R	Bearing Weight	C	Co
	Bore	Outside Diameter	Height	Housing & Shaft Fillet		Basic Dynamic Rating	Basic Static Rating
	inch mm	inch mm	inch mm	inch mm		lb kg	lb/N
T-7519	7.480 190.00	14.000 355.60	2.922 74.22	.25 6.4	76 34.5	490,000 2,195,200	1,893,000 8,480,640
T-811	8.000 203.20	16.500 419.10	3.625 92.08	.38 9.7	132 59.8	752,120 3,369,500	2,879,160 12,898,640
T-9020	9.000 228.60	17.000 431.80	3.495 88.77	.38 9.7	136 61.7	744,400 3,334,910	2,883,000 12,915,840
T-911	9.000 228.60	19.000 482.60	4.125 104.78	.44 11.2	237 107.5	991,250 4,440,800	3,796,762 17,009,490
T-911A	9.250 234.95	19.000 482.60	4.125 104.78	.44 11.2	232 105.2	991,250 4,440,800	3,796,762 17,009,490
T-921	9.250 234.95	21.500 546.10	5.000 127.00	.44 11.2	351 159.2	1,361,600 6,099,970	5,346,100 23,950,530
T-537504	9.500 241.30	19.500 495.30	5.000 127.00	.44 11.2	287 130.2	1,050,000 4,704,000	3,900,000 17,472,000
T-1011	10.000 254.00	21.125 536.58	4.625 117.48	.44 11.2	320 145.1	1,230,400 5,512,190	4,874,000 21,835,520
T-539210	10.750 273.05	21.750 552.45	5.250 133.35	.44 11.2	364 165.1	1,257,000 5,631,360	4,800,000 21,504,000
T-539211	10.750 273.05	23.750 603.25	5.750 146.05	.44 11.2	496 224.9	1,522,000 6,818,560	6,003,000 26,893,440
T-1120	11.000 279.40	23.750 603.25	5.375 136.53	.44 11.2	490 222.2	1,573,660 7,050,000	6,286,210 28,162,220
T-16021	16.000 406.40	28.000 711.20	5.750 146.05	.38 9.7	575 260.8	1,746,000 7,822,080	6,726,000 30,132,480
T-16050	16.000 406.40	33.000 838.20	7.000 177.80	.50 12.7	1,165 528.4	2,877,500 12,891,200	11,295,180 50,602,410

Metric dimensions for reference only.
 Not all parts are available from stock. Please contact customer service for availability (800) 626-2120.
 For more information on bearing capabilities outside of our standard offering, please contact Application Engineering (800) 626-2093.

Thrust Bearing Engineering see page F-44.

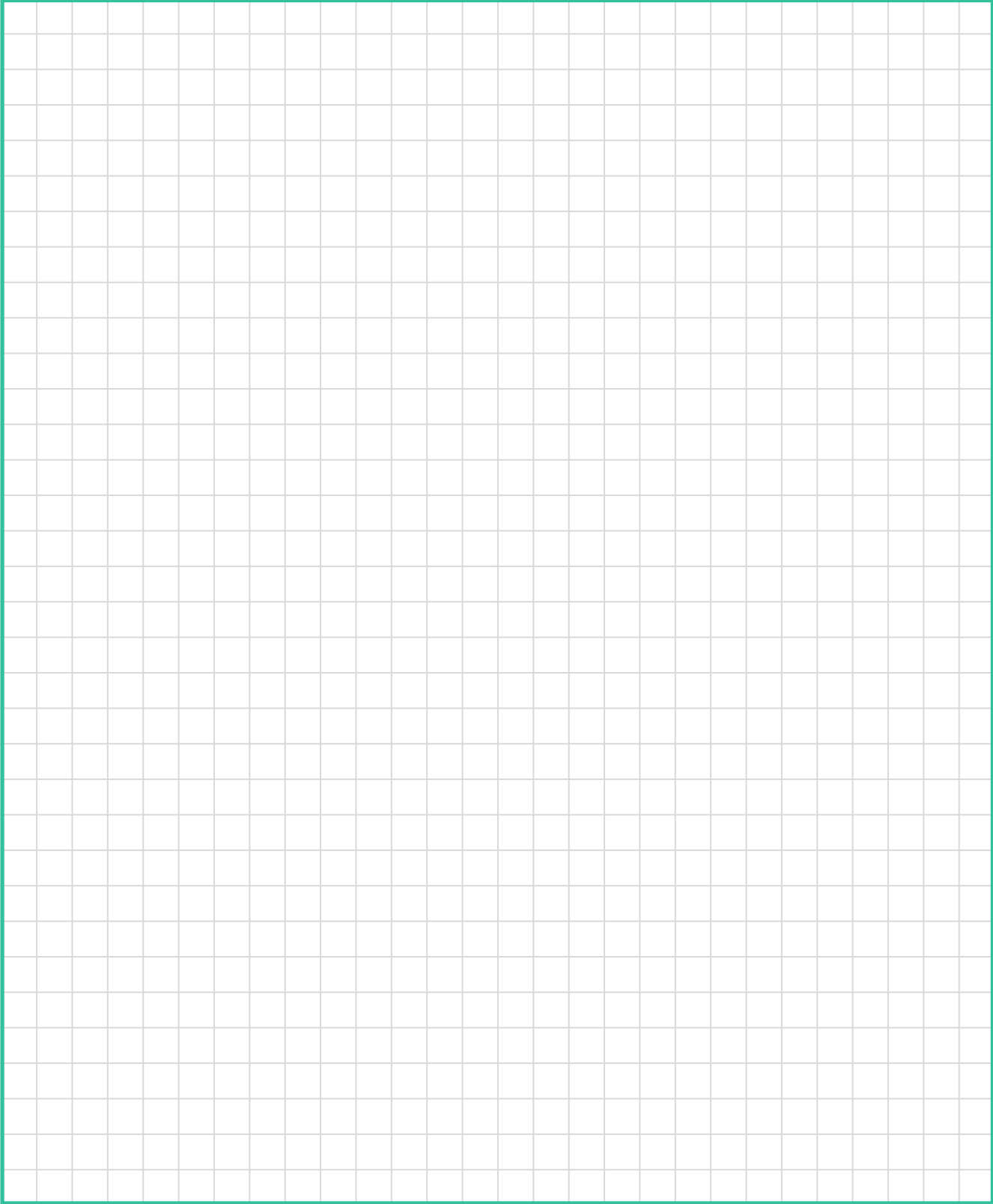

For more information on bearing capabilities outside of our standard offering, please contact Application Engineering (800) 626-2093.

Load Ratings and Life

Life Calculations

The L10 (rating) life for any given application and bearing selection can be calculated in terms of millions of revolutions by using the bearing Basic Dynamic Rating and applied thrust load. The L10 life for any given application can be calculated in terms of hours, using the bearing Basic Dynamic Rating, applied load and suitable speed factors, by the following equation:

For thrust cylindrical roller and thrust tapered roller bearings:

$$L_{10} = \left(\frac{C}{P}\right)^{10/3} \times \frac{1,000,000}{60 \times n} = \left(\frac{C}{P}\right)^{10/3} \times \frac{16667}{n}$$

Where:

L_{10} = The # of hours that 90% of identical bearings under ideal conditions will operate at a specific speed and condition before fatigue is expected to occur.

C = Basic Dynamic Rating (lbs)
1,000,000 Revolutions

P = Constant Equivalent Load (lbs)

n = Speed (RPM)

Additionally, the ABMA provides application factors for all types of bearings which need to be considered to determine an adjusted Rated Life (L_{na}). L10 life rating is based on laboratory conditions yet other factors are encountered in actual bearing application that will reduce bearing life. L_{na} life rating takes into account reliability factors, material type, and operating conditions.

$$L_{na} = a_1 \times a_2 \times a_3 \times L_{10}$$

Where:

L_{na} = Adjusted Rated Life.

a_1 = Reliability Factor. Adjustment factor applied where estimated fatigue life is based on reliability other than 90% (See Table No 1).

a_2 = Material Factor. Life adjustment for bearing race material. Regal Power Transmission Solutions bearing races

Table No. 1 Life Adjustment Factor for Reliability

Reliability %	L_{na}	a_1
90	L10	1
95	L5	0.62
96	L4	0.53
97	L3	0.44
98	L2	0.33
99	L1	0.21
50	L50	5

are manufactured from bearing quality steel. Therefore the a_2 factor is 1.0.

a_3 = Life Adjustment Factor for Operating Conditions. This factor should take into account the adequacy of lubricant, presence of foreign matter, conditions causing changes in material properties, and unusual loading or mounting conditions. Assuming a properly selected and mounted bearing having adequate seals and lubricant operating below 250°F and tight fitted to the shaft, the a_3 factor should be 1.0.



Load Ratings and Life Continued

Vibration and shock loading can act as an additional loading to the steady expected applied load. When shock or vibration is present, an a3 Life Adjustment Factor can be applied. Shock loading has many variables which often are not easily determined. Typically, it is best to rely on one's experience with the particular application. Consult Application Engineering for assistance with applications involving shock or vibration loading.

The a3 factor takes into account a wide range of application and mounting conditions as well as bearing features and design. Accurate determination of this factor is normally achieved through testing and in-field experience. Regal Power Transmission Solutions offers a wide range of options which can maximize bearing performance. Consult Application Engineering for more information.

Variable Load Formula

Root mean load (RML) is to be used when a number of varying loads are applied to a bearing for varying time limits. Maximum loading still must be considered for bearing size selection.

$$RML^* = \sqrt[10/3]{\frac{(L_1^{10/3} N_1) + (L_2^{10/3} N_2) + (L_3^{10/3} N_3)}{100}}$$

Where:

RML = Root Mean Load (lbs.)

L₁, L₂, etc. = Load in pounds

N₁, N₂, etc. = Percent of total time operated at loads L₁, L₂, etc.

* Apply RML to rating at mean speed to determine resultant life.

Mean Speed Formula

The following formula is to be used when operating speed varies over time.

$$\text{Mean Speed} = \frac{S_1 N_1 + S_2 N_2 + S_3 N_3}{100}$$

S₁, S₂, etc = Speeds in RPM

N₁, N₂, etc = Percentage of total time operated at speeds S₁, S₂, etc

Load Ratings and Life Continued

Bearing Life In Oscillating Applications

The equivalent rotative speed (ERS) is used in life calculations when the bearing does not make complete revolutions during operation. The ERS is then used as the bearing operating speed in the calculation of the L10 (Rating) Life. The formula is based on sufficient angular rotation to have roller paths overlap.

$$\begin{aligned} \text{ERS} &= \text{Equivalent Rotative Speed} \\ \text{N} &= \text{Total number of degrees per minute through} \\ &\quad \text{which the bearing will rotate.} \\ \text{ERS} &= \frac{\text{N}}{360} \end{aligned}$$

In the above formula, allowance is made for the total number of stress applications on the weakest race per unit time, which, in turn, determines fatigue life and the speed factors. The theory behind fretting corrosion is best explained by the fact that the rolling elements in small angles of oscillation retrace a path over an unchanging area of the inner or outer races where the lubricant is prevented by inertia from flowing in behind the roller as the bearing oscillates in one direction. Upon reversal, this small area of rolling contact is traversed by the same roller in the dry state. The friction of the two unlubricated surfaces causes fretting corrosion and produces failures which are unpredictable from a normal life standpoint.

With a given bearing selected for an oscillating application, the best lubrication means is a light mineral oil under positive flow conditions. With a light oil, there is a tendency for all areas in the bearing load zone to be immersed in lubricant at all times. The full flow lubrication dictates that any oxidized material which may form is immediately carried away by the lubricant, and since these oxides are abrasive, further wear tends to be avoided. If grease lubrication must be used, it is best to consult with either the bearing manufacturer or the lubricant manufacturer to determine the best possible type of lubricant. Greases have been compounded to resist the detrimental effect of fretting corrosion for such applications.

Static Load Rating

The "static load rating" for rolling element bearings is that uniformly distributed static radial load acting on a non-rotating bearing, which produces a contact stress of 580,000 psi (roller bearings) or 630,000 psi (ball bearings) at the center of the most heavily loaded rolling element. At this stress level, plastic deformation begins to be significant. Experience has shown that the plastic deformation at this stress level can be tolerated in most bearing applications without impairment of subsequent bearing operation. In certain applications where subsequent rotation of the bearing is slow and where smoothness and friction requirements are not too exacting, a higher static load limit can be tolerated. Where extreme smoothness is required or friction requirements are critical, a lower static load limit may be necessary.

Minimum Bearing Load

Skidding, or sliding, of the rolling elements on the raceway instead of a true rolling motion can cause excessive wear. Applications with high speeds and light loading are particularly prone to skidding. As a general guideline, rolling element bearings should be radially loaded at least 2% of Basic Dynamic Rating. For applications where load is light relative to the bearings dynamic load rating, consult Application Engineering for assistance.

Thrust Engineering Section



Rollway cylindrical roller thrust bearings are designed to support thrust loads (loads parallel to the axis of rotation) at relatively high speeds. Cylindrical roller thrust bearings are relatively stiff, require a minimum amount of axial space, and handle shock loading relatively well. Rollway manufactures four different styles of cylindrical roller thrust bearings:

1. Single Acting – Supports thrust or axial load in one direction.
2. Aligning – Accepts an initial static misalignment of not more than 3 degrees.
3. Double Acting – Supports thrust or axial load in two directions.
4. Crane Hook Thrust – A shielded cylindrical roller thrust bearing that supports thrust or axial load in one direction.

Rollway tapered thrust bearings (TTHD and TTVF) are engineered for applications that contain high thrust loads and heavy shock loads. These bearings feature tapered or conical rollers positioned between two plates with tapered raceways. The tapered thrust bearing allows for true rolling motion with the vertex of the conical sections intersecting the bearing axis. The large end of each tapered roller is spherically ground. When the bearing is under load, this curvature guides the rollers accurately. The large spherical end of the roller is counterbored to improve lubrication between the roller and guide rib. By virtue of the additional contact surface, these bearings will have a higher dynamic rating than a similar sized cylindrical roller thrust bearing. Furthermore, they have superior performance in horizontal shaft applications. The self-centering action of the rollers counteract the gravitational effect of the roller assembly reducing the effects of the roller assembly contacting the shaft.

The tapered thrust bearings of the TTVF style are similar to the TTHD tapered thrust style except one thrust plate is flat. The guide rib on the one tapered raceway resists the induced radial force component caused by the inclined plane while the flat plate allows radial displacement without adversely affecting bearing operation. Maximum capacity is achieved through close spacing of the rollers through the use of a steel, hardened pin type retainer.

Rollway tandem thrust bearings, also referred to as multi-stage thrust bearings, were originally designed and patented by Rollway. The bearing consists of a series of thrust plates and roller assemblies with compression sleeves separating the stages. The design of the bearing sleeves and precision match grinding of the components allow the load to be equally applied through the stages of the bearing.

The tandem design allows the use of a high capacity bearing in a small area. Popular applications for this bearing type are rotary swivels, single screw extruders, and twin screw extruders. The tandem bearing allows for the increased output of machines without increasing the size of the gearbox. Rollway manufactures tandem bearings in two, three, four, six, and eight stages. Both inch and metric series sizes are available. Bore sizes range from about 1 to 22 inches with corresponding outside diameter ranging from 3.5 to 42 inches. Rollway tandem thrust bearings are supplied to original equipment manufacturers and the aftermarket.

Operating Conditions Factor

The life of a bearing is dependent on the operating conditions of the application. Lubrication, effects of the external environment, shaft and housing geometry and mounting, all have an effect on the actual bearing life. To determine a more realistic life calculation, the Operating Conditions Factor (F) can be included into the L_{10} life equation. The actual values determination will be based on experience of the designer and the expected operating conditions.

Using the Operating Conditions Factor (F) in the life equation, L_{10} life in hours now becomes:

$$L_{10} = F \times \left[\left(\frac{C}{P} \right)^{3.33} \times \frac{16667}{n} \right]$$

Thrust Engineering Section continued

Proper selection of the F factor demands intimate knowledge of the application. Where little is known of the application, it is recommended that F = 1 be selected. As a guide in selecting a realistic value for F, Rollway suggests use of the following, cumulative, individual sub-factors, f, to arrive at the over-all factor, F, thus:

$$F = f_1 \times f_2 \times f_3 \times f_4 \dots$$

The table below defines the application parameters and values recommended for derivation of the individual sub-factors.

Thrust Bearing Factors

Factor	Application Condition	Factor Estimates	
		Poor	Excellent
f_1	Lubricant viscosity suitability @ bearing operating temperature (see Lubrication)	.5	1.0
f_2	External environment and provisions for isolation	.5	1.0
f_3	Operational conditions of shaft and housing squareness & rigidity	.5	1.0
f_4	Bearing thrust plate backing system full backing vs partial backing	.5	1.0



Cylindrical Roller Thrust Shaft Plate

The bore of the shaft plate is precision ground for a line to loose fit on in relation to the shaft outside diameter. The shaft plate outside diameter has a turned finish and is smaller than the housing plate's outside diameter. The plate is made from either through-hardened or carburizing grade steel with hardness to Rockwell (Rc) 58-63. Upon request we can manufacture these components from either CEVM or VIMVAR grades of material or M- 50 tool steel for high temperature applications.

All thrust plates are accurately ground for flatness and parallelism of the roller riding and backing surfaces. The roller contacting surfaces of the plates are superfinished to provide for long life. Locating diameters are ground to obtain an accurate fit on the shaft.



Cylindrical Roller Thrust Housing Plate

The outside diameter of the housing plate is precision ground for a line to loose fit in housing bore. The inside diameter has a turned finish and is larger than the shaft plate's inside diameter. The plate is made from either through-hardened or carburizing grade steel with hardness to Rockwell (Rc) 58-63. Upon request we can manufacture these components from either CEVM or VIMVAR grades of material or M- 50 tool steel for high temperature applications.

All thrust plates are accurately ground for flatness and parallelism of the roller riding and backing surfaces. The roller contacting surfaces of the plates are superfinished to provide for long life. Locating diameters are ground to obtain an accurate fit in the housing.

Thrust Engineering Section continued

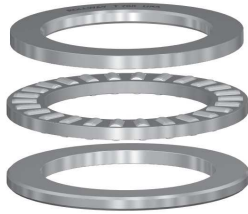

Cylindrical Roller Thrust Roller Assembly

The roller assembly contains a machined brass roller-riding cage. Rollway thrust bearing retainers are machined from centrifugally cast brass. The retainers for all cylindrical roller thrust bearings are designed to be roller riding. The contoured roller pockets are accurately machined at right angles to the thrust force, which will be applied to the bearing. The rollers are retained in the assembly by a steel ring pinned to the outside diameter of the retainer.

The rollers in the roller assembly are matched to have outside diameters within .0001 inches. It should be noted that the Rollway design has a sphered roller end, which rides against the steel retaining ring for reduced wear. (The center of the contact point has zero velocity vs. the higher velocity that results from a flat ended roller contacting the ring.) The rollers used in cylindrical thrust roller bearings are also crowned. For the benefits of crowning please refer to page F-9.



Tapered Thrust Bearing Plates

The tapered thrust plates and rollers are made from carburizing grade steel surface hardened to HRc 58 minimum. Other material grades such as CEVM or VIMVAR are available upon request. All thrust plates are accurately ground for flatness and parallelism of the roller riding and backing surfaces. Locating plate diameters are surface ground to obtain an accurate fit on the shaft or in the housing. The tapered roller contacting surfaces are ground to ensure satisfactory bearing operating life.



Tapered Thrust Bearing Rollers

The tapered rolling elements are precision ground to provide an even load over the contact surfaces. The rollers are crowned for optimum stress patterns. The large end of the rollers are spherically ground providing controlled contact between the rollers and the guide rib.



Tapered Thrust Bearing Retainer

The tapered thrust bearing retainers are of two designs. The first design is a machined retainer from a single piece of centrifugally cast brass. The second design is a two-piece retainer made from hardened steel rings.

Tolerances

Rollway thrust bearings are produced to standard tolerances as listed in the following tables. Thrust bearings are available to increased accuracy upon request. Cylindrical roller thrust bearings contain rollers having a diameter variation of .0001 inches maximum per bearing.



Thrust Engineering Section continued

600 Series, Single Direction, Flat Seats

Bore Diameter		Bore Tolerance		Height Tolerance	
over	incl	high (+)	low (-)	high (+)	low (-)
inch mm	inch mm	inch mm	inch mm	inch mm	inch mm
0.0000 0.0000	1.1870 30.1498	0.0000 0.0000	0.0005 0.0127	0.0000 0.0000	0.0060 0.1524
1.1870 30.1498	1.3750 34.9250	0.0000 0.0000	0.0006 0.0152	0.0000 0.0000	0.0060 0.1524
1.3750 34.9250	1.5620 39.6748	0.0000 0.0000	0.0007 0.0178	0.0000 0.0000	0.0060 0.1524
1.5620 39.6748	1.7500 44.4500	0.0000 0.0000	0.0008 0.0203	0.0000 0.0000	0.0060 0.1524
1.7500 44.4500	1.9370 49.1998	0.0000 0.0000	0.0009 0.0229	0.0000 0.0000	0.0060 0.1524
1.9370 49.1998	2.0000 50.8000	0.0000 0.0000	0.0010 0.0254	0.0000 0.0000	0.0060 0.1524
2.0000 50.8000	2.1250 53.9750	0.0000 0.0000	0.0010 0.0254	0.0000 0.0000	0.0080 0.2032
2.1250 53.9750	2.5000 63.5000	0.0000 0.0000	0.0011 0.0279	0.0000 0.0000	0.0080 0.2032
2.5000 63.5000	3.0000 76.2000	0.0000 0.0000	0.0012 0.0305	0.0000 0.0000	0.0080 0.2032
3.0000 76.2000	3.5000 88.9000	0.0000 0.0000	0.0013 0.0330	0.0000 0.0000	0.0100 0.2540

Outside Diameter		Outside Diameter Tolerance	
over	incl	high (+)	low (-)
inch mm	inch mm	inch mm	inch mm
0.0000 0.0000	2.8750 73.0250	0.0005 0.0127	0.0000 0.0000
2.8750 73.0250	3.3750 85.7250	0.0007 0.0178	0.0000 0.0000
3.3750 85.7250	3.7500 95.2500	0.0009 0.0229	0.0000 0.0000
3.7500 95.2500	4.1250 104.7750	0.0011 0.0279	0.0000 0.0000
4.1250 104.7750	4.7180 119.8372	0.0013 0.0330	0.0000 0.0000
4.7180 119.8372	5.0000 127.0000	0.0015 0.0381	0.0000 0.0000

Thrust Engineering Section continued

600 Series, Single Direction, Aligning Seat With Aligning Washers



Bore Diameter		Bore Tolerance		Height Tolerance	
over	incl	high (+)	low (-)	high (+)	low (-)
inch mm	inch mm	inch mm	inch mm	inch mm	inch mm
0.0000 0.0000	1.1870 30.1498	0.0000 0.0000	0.0005 0.0127	0.0000 0.0000	0.0060 0.1524
1.1870 30.1498	1.3750 34.9250	0.0000 0.0000	0.0006 0.0152	0.0000 0.0000	0.0060 0.1524
1.3750 34.9250	1.5620 39.6748	0.0000 0.0000	0.0007 0.0178	0.0000 0.0000	0.0060 0.1524
1.5620 39.6748	1.7500 44.4500	0.0000 0.0000	0.0008 0.0203	0.0000 0.0000	0.0060 0.1524
1.7500 44.4500	1.9370 49.1998	0.0000 0.0000	0.0009 0.0229	0.0000 0.0000	0.0060 0.1524
1.9370 49.1998	2.0000 50.8000	0.0000 0.0000	0.0010 0.0254	0.0000 0.0000	0.0060 0.1524
2.0000 50.8000	2.1250 53.9750	0.0000 0.0000	0.0010 0.0254	0.0000 0.0000	0.0080 0.2032
2.1250 53.9750	2.5000 63.5000	0.0000 0.0000	0.0011 0.0279	0.0000 0.0000	0.0080 0.2032
2.5000 63.5000	3.0000 76.2000	0.0000 0.0000	0.0012 0.0305	0.0000 0.0000	0.0080 0.2032
3.0000 76.2000	3.5000 88.9000	0.0000 0.0000	0.0013 0.0330	0.0000 0.0000	0.0100 0.2540

Outside Diameter		Outside Diameter Tolerance	
over	incl	high (+)	low (-)
inch mm	inch mm	inch mm	inch mm
0.0000 0.0000	3.0000 76.2000	0.0007 0.0178	0.0000 0.0000
3.0000 76.2000	3.3750 85.7250	0.0009 0.0229	0.0000 0.0000
3.3750 85.7250	3.6250 92.0750	0.0011 0.0279	0.0000 0.0000
3.6250 92.0750	3.8750 98.4250	0.0013 0.0330	0.0000 0.0000
3.8750 98.4250	4.5312 115.0925	0.0015 0.0381	0.0000 0.0000
4.5312 115.0925	5.0000 127.0000	0.0017 0.0432	0.0000 0.0000

Thrust Engineering Section continued

700 Series, Single Direction, Flat Seats

Bore Diameter		Bore Tolerance		Height Tolerance	
over	incl	high (+)	low (-)	high (+)	low (-)
inch mm	inch mm	inch mm	inch mm	inch mm	inch mm
2.0000 50.8000	3.0000 76.2000	0.0000 0.0000	0.0010 0.0254	0.0000 0.0000	0.0080 0.2032
3.0000 76.2000	3.5000 88.9000	0.0000 0.0000	0.0012 0.0305	0.0000 0.0000	0.0100 0.2540
3.5000 88.9000	6.0000 152.4000	0.0000 0.0000	0.0015 0.0381	0.0000 0.0000	0.0100 0.2540
6.0000 152.4000	9.0000 228.6000	0.0000 0.0000	0.0015 0.0381	0.0000 0.0000	0.0150 0.3810
9.0000 228.6000	10.0000 254.0000	0.0000 0.0000	0.0018 0.0457	0.0000 0.0000	0.0150 0.3810
10.0000 254.0000	12.0000 304.8000	0.0000 0.0000	0.0018 0.0457	0.0000 0.0000	0.0200 0.5080
12.0000 304.8000	18.0000 457.2000	0.0000 0.0000	0.0020 0.0508	0.0000 0.0000	0.0200 0.5080
18.0000 457.2000	22.0000 558.8000	0.0000 0.0000	0.0025 0.0635	0.0000 0.0000	0.0250 0.6350
22.0000 558.8000	30.0000 762.0000	0.0000 0.0000	0.0030 0.0762	0.0000 0.0000	0.0250 0.6350

Outside Diameter		Outside Diameter Tolerance	
over	incl	high (+)	low (-)
inch mm	inch mm	inch mm	inch mm
5.0000 127.0000	10.0000 254.0000	0.0015 0.0381	0.0000 0.0000
10.0000 254.0000	18.0000 457.2000	0.0020 0.0508	0.0000 0.0000
18.0000 457.2000	26.0000 660.4000	0.0025 0.0635	0.0000 0.0000
26.0000 660.4000	34.0000 863.6000	0.0030 0.0762	0.0000 0.0000
34.0000 863.6000	44.0000 1,117.6000	0.0040 0.1016	0.0000 0.0000

Thrust Engineering Section continued

700 Series, Single Direction, Aligning Seat With Aligning Washers



Bore Diameter		Bore Tolerance		Height Tolerance	
over	incl	high (+)	low (-)	high (+)	low (-)
inch mm	inch mm	inch mm	inch mm	inch mm	inch mm
2.0000 50.8000	3.0000 76.2000	0.0000 0.0000	0.0010 0.0254	0.0000 0.0000	0.0100 0.2540
3.0000 76.2000	3.5000 88.9000	0.0000 0.0000	0.0012 0.0305	0.0000 0.0000	0.0150 0.3810
3.5000 88.9000	6.0000 152.4000	0.0000 0.0000	0.0015 0.0381	0.0000 0.0000	0.0150 0.3810
6.0000 152.4000	9.0000 228.6000	0.0000 0.0000	0.0015 0.0381	0.0000 0.0000	0.0200 0.5080
9.0000 228.6000	10.0000 254.0000	0.0000 0.0000	0.0018 0.0457	0.0000 0.0000	0.0200 0.5080
10.0000 254.0000	12.0000 304.8000	0.0000 0.0000	0.0018 0.0457	0.0000 0.0000	0.0250 0.6350
12.0000 304.8000	18.0000 457.2000	0.0000 0.0000	0.0020 0.0508	0.0000 0.0000	0.0250 0.6350
18.0000 457.2000	22.0000 558.8000	0.0000 0.0000	0.0025 0.0635	0.0000 0.0000	0.0300 0.7620

Outside Diameter		Outside Diameter Tolerance	
over	incl	high (+)	low (-)
inch mm	inch mm	inch mm	inch mm
5.0000 127.0000	10.0000 254.0000	0.0019 0.0483	0.0000 0.0000
10.0000 254.0000	18.0000 457.2000	0.0021 0.0533	0.0000 0.0000
18.0000 457.2000	26.0000 660.4000	0.0023 0.0584	0.0000 0.0000
26.0000 660.4000	34.0000 863.6000	0.0025 0.0635	0.0000 0.0000
34.0000 863.6000	44.0000 1,117.6000	0.0030 0.0762	0.0000 0.0000

Thrust Engineering Section continued

Crane Hook

Bore Diameter		Bore Tolerance		Height Tolerance	
over	incl	high (+)	low (-)	high (+)	low (-)
inch mm	inch mm	inch mm	inch mm	inch mm	inch mm
0.0000 0.0000	2.0156 51.1962	0.0100 0.2540	0.0000 0.0000	0.0000 0.0000	0.0080 0.2032
2.0156 51.1962	3.0156 76.5962	0.0100 0.2540	0.0020 0.0508	0.0000 0.0000	0.0100 0.2540
3.0156 76.5962	6.0156 152.7962	0.0150 0.3810	0.0020 0.0508	0.0000 0.0000	0.0150 0.3810
6.0156 152.7962	10.1560 257.9624	0.0150 0.3810	0.0050 0.1270	0.0000 0.0000	0.0200 0.5080

Outside Diameter		Outside Diameter Tolerance	
over	incl	high (+)	low (-)
inch mm	inch mm	inch mm	inch mm
2.5000 63.5000	4.0000 101.6000	0.0050 0.1270	0.0050 0.1270
4.0000 101.6000	6.0000 152.4000	0.0060 0.1524	0.0060 0.1524
6.0000 152.4000	10.0000 254.0000	0.0100 0.2540	0.0100 0.2540
10.0000 254.0000	34.0000 863.6000	0.0120 0.3048	0.0120 0.3048

Thrust Engineering Section continued

Tapered Roller Thrust



Bore Diameter		Bore Tolerance		Height Tolerance	
over	incl	high (+)	low (-)	high (+)	low (-)
inch mm	inch mm	inch mm	inch mm	inch mm	inch mm
0.0000 0.0000	12.0000 304.8000	0.0010 0.0254	0.0000 0.0000	0.0150 0.3810	0.0150 0.3810
12.0000 304.8000	24.0000 609.6000	0.0020 0.0508	0.0000 0.0000	0.0150 0.3810	0.0150 0.3810
24.0000 609.6000	36.0000 914.4000	0.0030 0.0762	0.0000 0.0000	0.0150 0.3810	0.0150 0.3810
36.0000 914.4000	48.0000 1,219.2000	0.0040 0.1016	0.0000 0.0000	0.0150 0.3810	0.0150 0.3810

Outside Diameter		Outside Diameter Tolerance	
over	incl	high (+)	low (-)
inch mm	inch mm	inch mm	inch mm
0.0000 0.0000	12.0000 304.8000	0.0010 0.0254	0.0000 0.0000
12.0000 304.8000	24.0000 609.6000	0.0020 0.0508	0.0000 0.0000
24.0000 609.6000	36.0000 914.4000	0.0030 0.0762	0.0000 0.0000
36.0000 914.4000	48.0000 1,219.2000	0.0040 0.1016	0.0000 0.0000

Thrust Engineering Section continued

Thrust Bearing Mounting

Suitable tolerances for the shaft and housings of the 600 and 700 series thrust bearings and the tapered thrust bearings are listed in the following tables. These tolerances will provide satisfactory radial guidance for the cylindrical and/or tapered thrust bearings. For further information on bearing mounting and installation, refer to page F-56 of this catalog

Cylindrical Thrust Thrust Bearing Mounting Practice – Shaft and Housing Fits

Bearing		Shaft Diameter Deviation	
Bore Diameter		from Bore Diameter (-)	
over	incl	high	low
inch mm	inch mm	inch mm	inch mm
0.0000 0.0000	1.1250 28.5750	0.0005 0.0127	0.0015 0.0381
1.1250 28.5750	1.3125 33.3375	0.0006 0.0152	0.0016 0.0406
1.3125 33.3375	1.5000 38.1000	0.0007 0.0178	0.0017 0.0432
1.5000 38.1000	1.6875 42.8625	0.0008 0.0203	0.0018 0.0457
1.6875 42.8625	1.8750 47.6250	0.0009 0.0229	0.0019 0.0483
1.8750 47.6250	2.1250 53.9750	0.0010 0.0254	0.0020 0.0508
2.1250 53.9750	2.5000 63.5000	0.0011 0.0279	0.0021 0.0533
2.5000 63.5000	3.0000 76.2000	0.0012 0.0305	0.0022 0.0559
3.0000 76.2000	3.5000 88.9000	0.0013 0.0330	0.0023 0.0584
3.5000 88.9000	7.0000 177.8000	0.0015 0.0381	0.0025 0.0635
7.0000 177.8000	9.0000 228.6000	0.0015 0.0381	0.0030 0.0762
9.0000 228.6000	12.0000 304.8000	0.0018 0.0457	0.0033 0.0838
12.0000 304.8000	15.0000 381.0000	0.0020 0.0508	0.0035 0.0889
15.0000 381.0000	19.0000 482.6000	0.0020 0.0508	0.0040 0.1016
19.0000 482.6000	23.0000 584.2000	0.0025 0.0635	0.0045 0.1143
23.0000 584.2000	30.0000 762.0000	0.0030 0.0762	0.0055 0.1397

Thrust Engineering Section continued

Cylindrical Thrust

Thrust Bearing Mounting Practice – Shaft and Housing Fits continued



Bearing		Housing Diameter Deviation	
Outside Diameter		from Outside Diameter (+)	
over	incl	high	low
inch mm	inch mm	inch mm	inch mm
2.0000 50.8000	2.3750 60.3250	0.0015 0.0381	0.0005 0.0127
2.3750 60.3250	3.2500 82.5500	0.0017 0.0432	0.0007 0.0178
3.2500 82.5500	3.6875 93.6625	0.0019 0.0483	0.0009 0.0229
3.6875 93.6625	4.0000 101.6000	0.0021 0.0533	0.0011 0.0279
4.0000 101.6000	4.5312 115.0925	0.0028 0.0711	0.0013 0.0330
4.5312 115.0925	10.0000 254.0000	0.0030 0.0762	0.0015 0.0381
10.0000 254.0000	18.0000 457.2000	0.0040 0.1016	0.0020 0.0508
18.0000 457.2000	22.0000 558.8000	0.0050 0.1270	0.0025 0.0635
22.0000 558.8000	26.0000 660.4000	0.0055 0.1397	0.0025 0.0635
26.0000 660.4000	28.0000 711.2000	0.0060 0.1524	0.0030 0.0762
28.0000 711.2000	34.0000 863.6000	0.0070 0.1778	0.0030 0.0762
34.0000 863.6000	38.0000 965.2000	0.0080 0.2032	0.0035 0.0889
38.0000 965.2000	44.0000 1,117.6000	0.0090 0.2286	0.0040 0.1016

Thrust Engineering Section continued

Tapered Thrust

Thrust Bearing Mounting Practice – Shaft and Housing Fits

Thrust Bearings



Bearing		Spring Loaded Shaft Diameter Deviation	
Bore Diameter		from Bore Diameter (-)	
over	incl	high	low
inch mm	inch mm	inch mm	inch mm
0.0000 0.0000	6.8750 174.6250	0.0000 0.0000	0.0010 0.0254
6.8750 174.6250	7.9999 203.1975	0.0000 0.0000	0.0010 0.0254
7.9999 203.1975	12.0000 304.8000	0.0000 0.0000	0.0015 0.0381
12.0000 304.8000	24.0000 609.6000	0.0000 0.0000	0.0020 0.0508
24.0000 609.6000	36.0000 914.4000	0.0000 0.0000	0.0025 0.0635
36.0000 914.4000	48.0000 1,219.2000	0.0000 0.0000	0.0030 0.0762

Bearing		Housing Diameter Deviation	
Outside Diameter		from Outside Diameter (+)	
over	incl	high	low
inch mm	inch mm	inch mm	inch mm
0.0000 0.0000	10.5000 266.7000	0.0025 0.0635	0.0010 0.0254
10.5000 266.7000	13.0000 330.2000	0.0030 0.0762	0.0010 0.0254
13.0000 330.2000	20.0000 508.0000	0.0040 0.1016	0.0020 0.0508
20.0000 508.0000	25.0000 635.0000	0.0045 0.1143	0.0020 0.0508
25.0000 635.0000	30.0000 762.0000	0.0060 0.1524	0.0030 0.0762
30.0000 762.0000	35.0000 889.0000	0.0070 0.1778	0.0030 0.0762

Thrust Engineering Section continued

When mounting thrust bearings, there exists the possibility of a slight press fit due to the acceptable tolerances of the bearing bore and outside diameters. Under no circumstances should a press fit exceeding the limits shown be used with the thrust plates, as any expansion or contraction in the plates due to fit could result in a misalignment in the plates and subsequent limited bearing life.

Cylindrical and tapered roller thrust bearings require the support surfaces in the housing and the shaft to be at right angles to the shaft axis within .0005 inch per inch of diameter. For example, a four inch diameter shaft should be square to the shaft shoulder within .002 inches. The support surfaces should also provide for continuous support for the bearing thrust plates across the extent of the raceways. As a general rule, the minimum shaft shoulder and maximum housing shoulder should be as follows:

- Shaft shoulder at a minimum should be equal to the outside diameter of the shaft plate.
- Housing shoulder must have a maximum diameter to not exceed the inside diameter of the housing plate.

The tapered thrust bearing plates are manufactured with the same inside diameter and outside diameter on both plates. Applications using these bearings must be designed with ample clearance between the outside diameter of the shaft plate and the housing. Clearance must also be designed between the inside diameter of the housing plate and the shaft. It is recommended to provide for clearances of approximately .030 inches.

Tandem thrust bearings are designed to allow for the use of minimal shaft and housing shoulders. The cantilevering action of the thrust plates use of compression sleeves enable these bearings to be used effectively where only minimal shaft and housing shoulders exist.

Tandem Thrust Bearing Minimum Load

Tandem thrust bearings are designed to be used in horizontal shaft applications such as an extruder gear drive, and it is essential that a sufficient thrust load is applied to prevent roller skid. The minimum load required for tandem thrust bearings is expressed as a ratio of the bearing's dynamic rating (C) to the applied load (P). For ideal bearing operation, the C/P ratio should be less than 8. Bearing loads creating a C/P ratio greater than 12 must be avoided.

Lubrication

The required viscosity for the lubricant on cylindrical thrust bearings is 125 SSU at operating temperature. The required viscosity for the lubricant on tapered thrust bearings is 160 SSU at operating temperature. The required viscosity for the lubricant on tandem thrust bearings is 160 SSU at operating temperature. For further information in regards to thrust bearing lubrication please refer to page A-17 of this catalog.